

SHARP

Be Original.

MX-B707F MX-B557F

Digital Multifunctional System

Get Those Vital Document Jobs Done Faster



Quick Scanning

The MFP comes equipped with a highly efficient 150-sheet DSPF (duplex single pass feeder), which scans both pages of two-sided documents in one pass. With a scanning speed of up to 72 opm* (one-sided) or 144 opm* (two-sided), the MFP can finish even large projects quickly.

* Originals per minute; when feeding A4 sheets; 75 ppm (one-sided) or 150 opm (two-sided) for 8 1/2" x 11" sheets.

Front USB Port

At the front of the MFP is a USB port, which comes in handy when printing directly from a USB drive—an indispensable function for users who want quick machine access without a PC.

Output Options

The MFP comes with a range of output options: a four-bin mailbox with up to four output destinations; an offset stacker for easy document retrieval; and a compact finisher for stapling and hole punching.

QWERTY Keyboard*

A full-size QWERTY keyboard beneath the control panel makes text input fast and easy: convenient for typing things like e-mail addresses and messages, as well as passwords for user authentication.

* Requires optional 57X7030 or 57X7040.



A speedy document partner you can rely on

When you need high-quality monochrome documents at the press of a button, this compact MFP is your friend. It can be upgraded with wireless LAN connectivity, so everyone in the office can use it freely. You can even connect it to a network of other MFPs if you're installing it in a large office. Whether your business is established or just starting out, it will prove a valued all-round performer.

Wireless LAN Connections*

An optional wireless LAN is available that conforms to the IEEE 802.11 a/ac/b/g/n standards. This lets you connect to the MFP via network infrastructure or via Wi-Fi Direct® for mobile devices. Wi-Fi Direct allows peer-to-peer connection with compatible PCs and mobile devices. This comes in handy when you need quick access to an MFP—for example, one at a client's office. Because this wireless LAN is independent from an in-house network, you don't need to worry about security. What's more, it supports dual-band connectivity for both 2.4 GHz and 5 GHz wireless networks.

* Requires optional 27X6410 or 27X6510.

AirPrint Compatible

The MFP supports the AirPrint printing feature in Apple's iOS and macOS operating systems. AirPrint automatically detects MFPs and printers on the same network. It then lets you print directly from a mobile device without the need for a print driver.



Easy-to-Use Interface

Operating the MFP is easy and intuitive with the free-tilting control panel and 10.0-inch colour LCD touchscreen. In Easy UI mode, the touchscreen displays simple icons for frequently used functions. And with the Preview function, you can check the finish of a print and scan job in advance.



Device Management

Sharp Remote Device Manager* (SRDM) gives administrators centralised control of their networked MFPs and printers. This software covers system setup, security settings, troubleshooting, and more.

* Contact a Sharp customer representative for availability and other details.

Security

Protect your intellectual property. A wide range of security features help to keep your information safe, whether it's in a document, on the device, or over your network.

Efficient Output

This MFP delivers a fast output of 66/52 ppm*¹. The first copy comes out in 3.9/4.5 seconds*², saving you valuable time when performing multiple short-run jobs.

*1: A4, short-edge feeding; 70/55 ppm for 8 1/2" x 11" size.
*2: 3.9/4.3 seconds for 8 1/2" x 11" size.

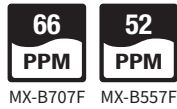

Ample Paper Capacity

Two 550-sheet trays and a 100-sheet multipurpose feeder come standard. An optional 550-sheet tray and a 2,100-sheet tray are available for a total paper capacity of 3,300 sheets.

ID Card Copy

The MFP lets you easily copy both sides of a card (ID cards, credit cards, etc.) onto a single page.

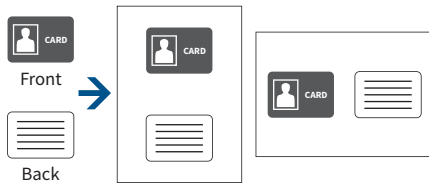

Office Direct Printing*

Print common Microsoft® Office files without using a PC. With this MFP, you can print a Word, Excel®, or PowerPoint® file directly from a mobile device, USB drive, or file server.

* The actual printout may look different from what is displayed on the computer screen.



Printer Driver with Easy Setup

The printer driver setup window features a simple design that includes larger buttons and drop-down menus, making it easier than ever to use printer functions.

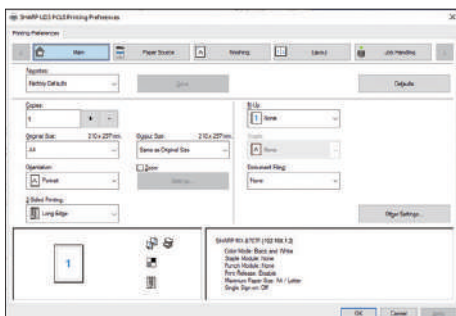

Versatile Paper Handling

With the main paper trays and multipurpose feeder, the MFP can handle a wide variety of paper—including cardstock, envelopes, and small media like A6-size paper.

Multiple Scan Destinations

Scanned documents can be distributed in a number of ways. For example, they can be sent as e-mail attachments or they can be scanned directly to an FTP server for storage. A compact PDF function ensures that PDF files are sent and received smoothly.

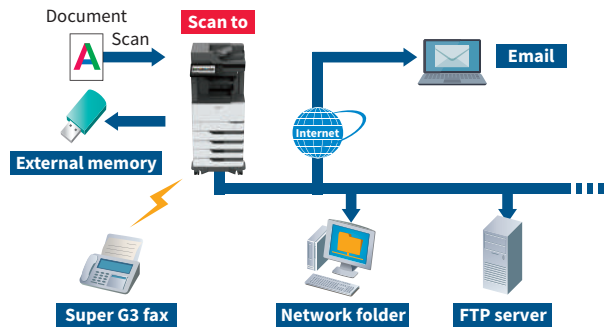

Convert Documents via OCR

OCR capability on this MFP lets you convert a scanned document into a searchable PDF file or into an editable Microsoft® Office Word file. This means you can do speedy text searches, even with large-volume documents, and you can easily copy and paste text data into other applications.

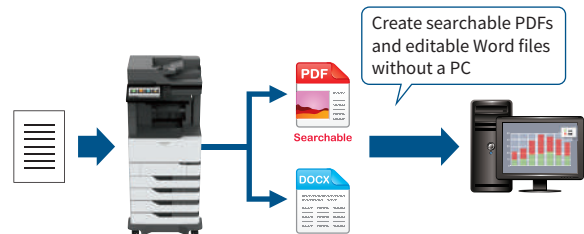

Convenient Faxing

The MFP supports colour faxes, paperless faxing, and other convenient functions. You can forward faxes to a pre-designated location, such as an FTP server, network folder, or email. This means you can check faxes even when you're out of the office. You can also block junk faxes, allowing you to save on wasted paper and toner. And, for extra security, you can hold incoming fax data and print it out at a time that suits you.

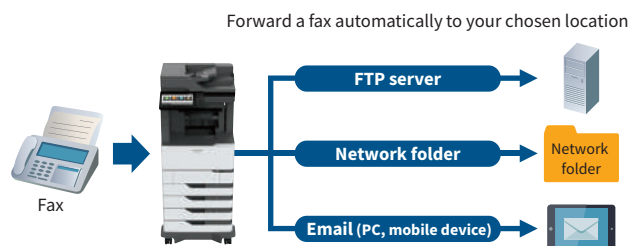

SPECIFICATIONS

General

Type	Console
Engine speed	A4*1: Max. 66/52 ppm 8 1/2" x 11"*1: Max. 70/55 ppm
Control panel display	10.0-inch colour LCD touchscreen
Paper size	Max. A4 (8 1/2" x 14"), min. A6 (5 1/2" x 8 1/2")
Paper capacity (75 g/m ²)	Standard: 1,200 sheets (550-sheet tray x 2 and 100-sheet multipurpose feeder) Maximum: 3,300 sheets (1,200 sheets & optional 2,100-sheet tray)
Paper weight	Tray: 60 g/m ² to 203 g/m ² (16 lbs bond to 125 lbs tag) Multipurpose feeder: 60 g/m ² to 203 g/m ² (16 lbs bond to 125 lbs tag) 2,100-sheet tray: 60 g/m ² to 135 g/m ² (16 lbs bond to 36 lbs bond)
Memory	Standard: 2 GB 500 GB HDD*2 Option: 4 GB
Dimensions (W x D x H)	685.8 x 693.4 x 1,150.6 mm (27.0" x 27.3" x 45.3")
Weight (approx.)	67.0 kg (147.6 lbs)

Copier

Original paper size	Max. A4 (8 1/2" x 14")
First copy time*3	A4: 3.9/4.5 sec. 8 1/2" x 11"*1: 3.9/4.3 sec.
Continuous copy	Max. 9,999 copies
Resolution	Max. 600 x 600 dpi
Zoom range	25% to 400% in 1% increments
Preset copy ratios	6 ratios (2R/4E)

Scanner

Scan method	Push scan (via control panel) Pull scan (TWAIN-compliant application)
Scan speed** (colour & B/W)	[A4] One-sided: Max. 72 originals/min. Two-sided: Max. 144 originals/min. [8 1/2" x 11"] One-sided: Max. 75 originals/min. Two-sided: Max. 150 originals/min.
Resolution	Push scan: 75, 150, 200, 300, 400, 600 dpi Pull scan: 75, 150, 200, 300, 400, 600, 1,200*5 dpi
File formats	TIFF, PDF, PDF/A-1a, PDF/A-1b, encrypted PDF, XPS, compact PDF*6, JPEG*6, searchable PDF, DOCX, CSV, text (TXT), rich text (RTF)
Scan destinations	Scan to e-mail/FTP server/USB drive/network folder (SMB)/HDD

Printer

Resolution	1,200 x 1,200 dpi, 600 x 600 dpi
Interface	USB 2.0 (host, high-speed), 10Base-T/100Base-TX/1000Base-T, wireless LAN (IEEE 802.11 a/ac/b/g/n)*7
Supported OS	Windows Server® 2008, Windows Server® 2008 R2, Windows Server® 2012 R2, Windows Server® 2016, Windows Server® 2019, Windows® 7, Windows® 8.1, Windows® 10 Mac OS 10.10, 10.11, 10.12, 10.13, 10.14, 10.15
Network protocols	TCP/IP
Printing protocols	LPD, Raw TCP (port 9100), enhanced IP (port 9400), FTP, TFTP, IPP
PDL	PCL 5e/PCL 6 emulation, PostScript® 3™ emulation
Available fonts	89 fonts for PCL, 158 fonts for PostScript 3 emulation

Facsimile

Compression method	MH/MR/MMR/JBIG/JBIG2/JPEG
Communication protocol	Super G3/G3
Transmission time	Less than 3 seconds*8
Modem speed	33,600 bps to 2,400 bps with automatic fallback
Transmission resolution	B/W: From Standard to Ultra Fine Colour: From Fine to Super Fine
Recording size	A4 to A6 (8 1/2" x 14" to 5 1/2" x 8 1/2")
Memory	1 GB (built-in)

*1: Short-edge feeding.
*2: HDD capacity depends on procurement and sourcing status.
*3: Short-edge feeding of A4 (8 1/2" x 11") sheets from 1st paper tray, using document glass, MFP in fully ready condition. May vary depending on operating conditions and environment.
*4: Scan speed will vary depending on the type of document, scan settings, operating conditions, and environment.
*5: 1,200 dpi scanning is B/W. Scanning requires a flatbed and a network or USB TWAIN driver, which performs some interpolation.
*6: Colour/greyscale only.
*7: Optional.
*8: Based on ITU-T test chart #1 at 33,600 bps.

• Design and specifications are subject to change without prior notice.
• Wi-Fi Direct® is a registered trademark of Wi-Fi Alliance®. AirPrint, Apple, macOS, and Mac are trademarks of Apple Inc., registered in the US and other countries. Microsoft, Excel, PowerPoint, Windows Server, and Windows are either registered trademarks or trademarks of Microsoft Corporation in the US and/or other countries. PCL is a registered trademark of Hewlett-Packard Company. PostScript 3 is either a registered trademark or trademark of Adobe in the US and/or other countries. All other brand names and product names may be trademarks or registered trademarks of their respective owners.

SYSTEM CONFIGURATION

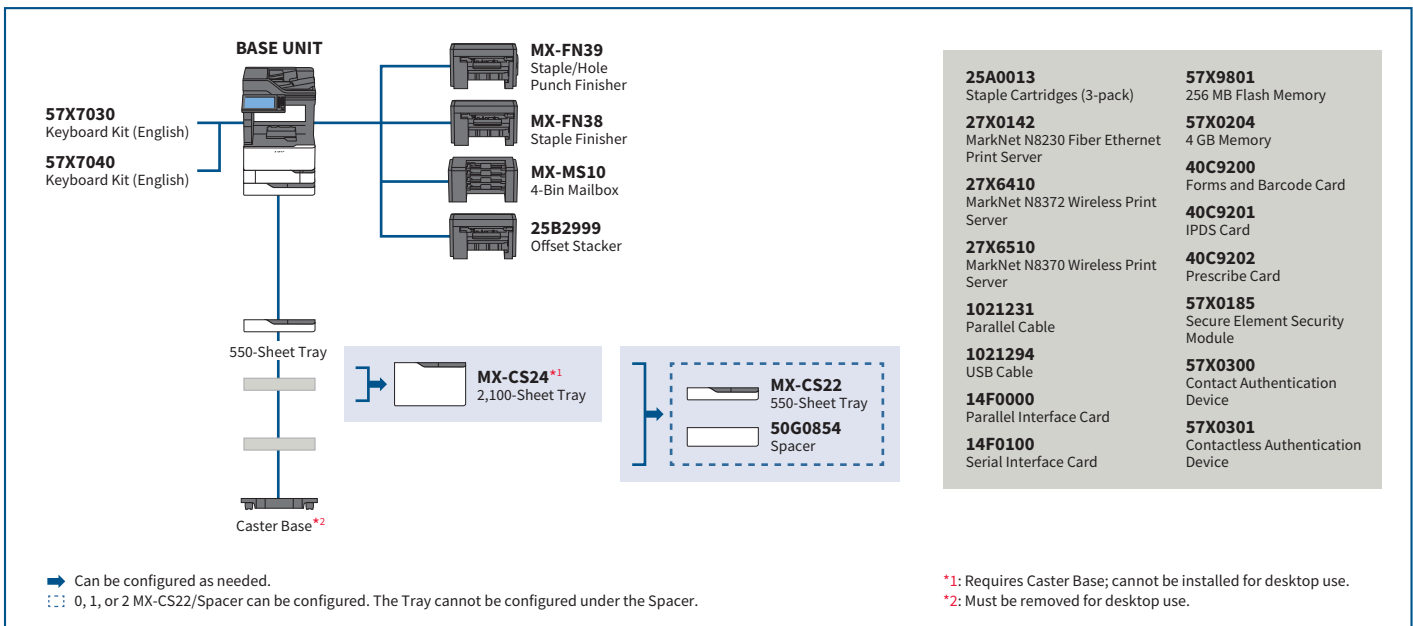

Certain optional equipment may not be available in some areas.

Distributed by:

