

SHARP

Be Original.

MX-M3550
MX-M3050

Digital Multifunction System



**The Workflow Creativity
You've Been Waiting For**



simply better **business**

Unsurpassed Performance for Simply Better Business

Get your business moving with the versatile MX-M3550/M3050. This trusty black-and-white MFP offers advanced functionality that you can access easily through a user-friendly UI. No surprise that it shares part of its design DNA with Sharp's latest colour MFPs. Thanks to its smart array of features, the MX-M3550/M3050 helps you produce, manage, and share high-quality documents. Whether on its own or in an MFP network, it offers the reliability your office needs for everyday document production.



Home screen



Simply Better Process

Transform the way you use information in your business by connecting one of these new MFPs to a variety of mobile devices and cloud services. Now you don't have to be confined to the office—you and your team can work anytime, anywhere. The amazing flexibility of these Sharp MFPs can help you grab new business opportunities and boost your bottom line.

Business owners / directors

Link to Public Cloud and Mobile Printing Services*

These MFPs enable single sign-on for easy access to public cloud services such as Google Drive™, OneDrive® for Business, SharePoint® Online, and Box. They also support mobile printing services such as Google Cloud Print™, AirPrint, and Sharp Print Service Plugin.

* For details, see pages 5 and 6.

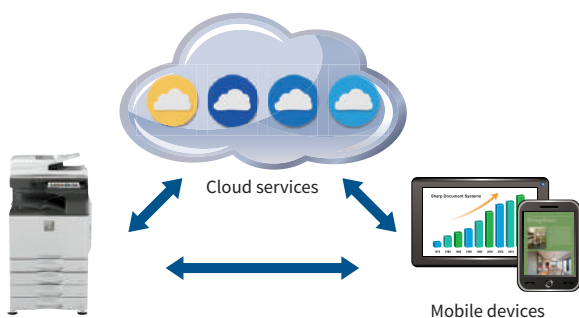

Convert Documents via OCR*

OCR capability on the MX-M3550/M3050 lets you convert a scanned document into a searchable PDF file or into an editable Office Open XML (docx, xlsx, pptx) file. This means you can do speedy text searches, even with large-volume documents, and you can easily copy and paste text data into other applications.

* Requires optional MX-EB20.

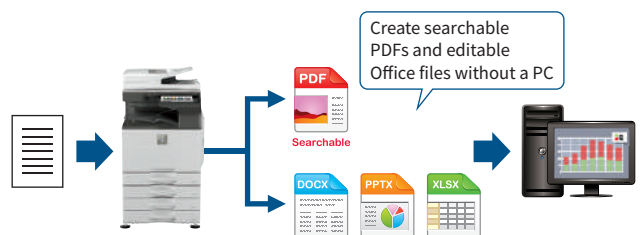



Office users

Simply Better Experience

Sharp's proprietary technologies give each of these MFPs quick warm-up and first copy times. Thanks to their intuitive operation, quick recovery from standby, and superb usability, the MX-M3550/M3050 simplifies even the most complex work processes and help you finish document jobs fast.

Easy User Interface

The intuitive Easy UI mode makes it easy for anyone to use the MFP's advanced functions. In this mode, simple function icons are displayed on the 10.1-inch colour LCD touchscreen. Each user can customise the home screen by drag-and-dropping icons for commonly used functions, making for smoother, more efficient operation.

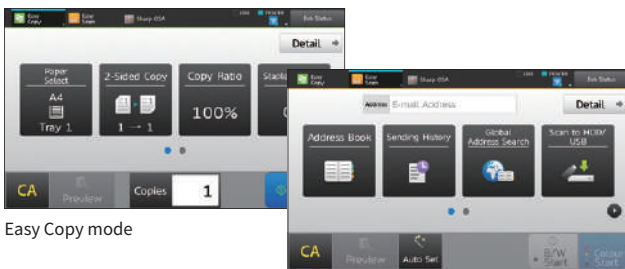

Easy Copy mode

Easy Scan mode

Fast Wake Up from Sleep Mode

These MFPs recover quickly from energy-saving Sleep mode. Placing a document in the RSPF or touching the LCD control panel wakes the MFP up in just one second*. This helps to minimise waiting time and get your jobs done faster.

* When in Fast Wake Up mode.



IT managers / administrators

Simply Better Admin

These MFPs fit securely and seamlessly into your office system. An advanced security environment and easily viewable administration tools reduce the workload for system administrators and give full support to their management duties.

Secure Access Control

The MX-M3550/M3050 supports the **Active Directory**® service, which lets you use the machine's log-on credentials for network folders. With centralised management of multiple user credentials, system administrators are able to keep track of MFP usage, which makes for an efficient and highly secure operational environment. And with **single sign-on**, you can access cloud services and internal network folders from the MX-M3550/M3050 by simply logging in to the MFP—there's no need to re-enter your IDs and passwords.

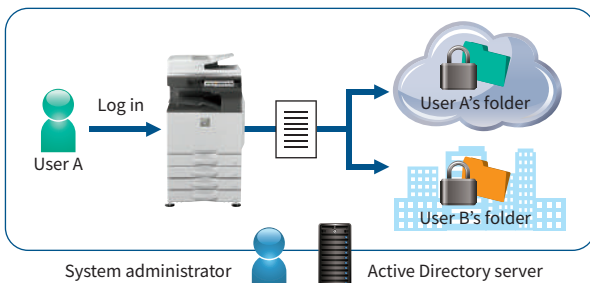

Integrated Device Management

As a system administrator, you can get the most out of a Sharp document system by using Sharp's efficiency-boosting device management tools. From a single location, you can use Sharp Remote Device Manager* (SRDM) to manage multiple Sharp MFPs. This includes everything from system setup, user access, and security settings to troubleshooting and maintenance.

* Contact a Sharp customer representative for availability and other details.

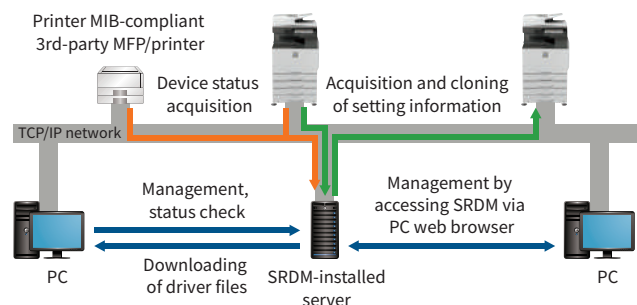

Super-Efficient Output

The MX-M3550/M3050 delivers a fast output of 35/30 ppm*. The first copy comes out in just 4.5 seconds, saving you valuable time when performing multiple short-run jobs.

* A4 (8 1/2" x 11"), long-edge feeding

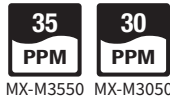

Versatile Paper Handling

Maximum paper capacity on the MX-M3550/M3050 is 6,300 sheets. Most of the paper trays accommodate a wide variety of paper, in sizes up to A3W and in weights up to 300 g/m². These MFPs can also handle extra-long paper up to 1,300 mm*. In addition to plain paper, the MFPs accommodate a number of other paper types, including coated, textured, and removable adhesive paper.

* Sharp recommends using the optional MX-LT10 for this function. Contact a Sharp customer representative for details.



Print Release*

The Print Release function lets you send documents to the main MFP, which acts as a server and stores them for printing out from any other compatible MFP on the network. This function comes in handy when the main MFP is in use or under maintenance, letting you finish your job with minimal waiting.

* Main MFP requires optional MX-HD16 (connected MFPs do not). There is a limit to the maximum number of connectable MFPs. Contact a Sharp customer representative for details.

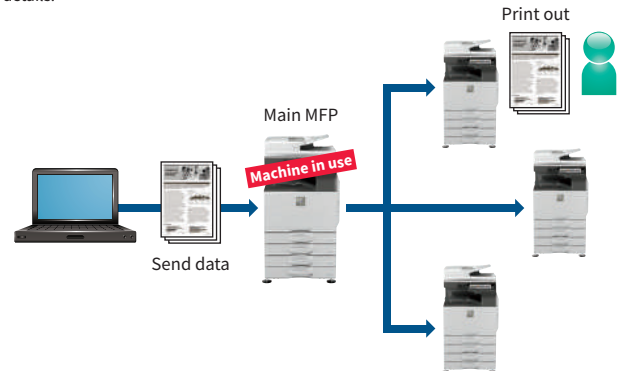

Job Separator Tray

The Job Separator Tray option prevents copy/print/fax jobs from getting mixed together. Thanks to this interior output tray system, the MFP can provide up to four output destinations when it's equipped with an exit tray and external finisher.

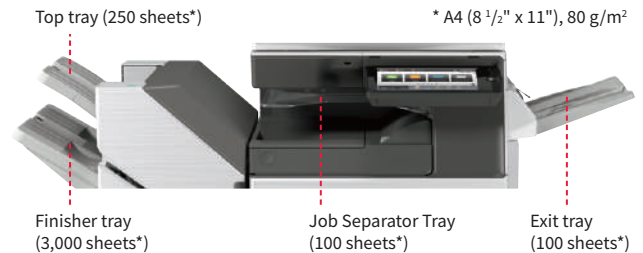

Finisher Options

These MFPs offer plenty of finishing options to suit a variety of workplaces and applications.

	MX-FN27 N Finisher	MX-FN28 Finisher	MX-FN29 Saddle Stitch Finisher	MX-FN30 Finisher	MX-FN31 Saddle Stitch Finisher
Max. paper capacity* ¹	500 sheets	1,250 sheets	1,250 sheets	3,250 sheets	3,250 sheets
Stapleless stapling	Yes	-	-	Yes	Yes
Manual stapling	Yes	-	-	Yes	Yes
Saddle stitching	-	-	Yes	-	Yes
Punching* ²	Yes	Yes	Yes	Yes	Yes

*1: A4 (8 1/2" x 11"), 80 g/m²

*2: Requires optional punch module

Stapling

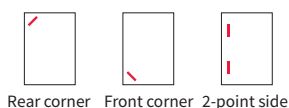

Punching

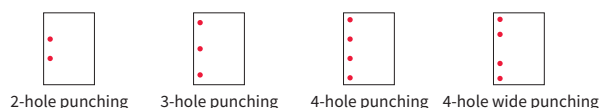

Saddle stitching

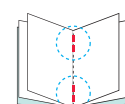

Stapleless Stapler

To make paper recycling easy and to save on stapler costs, a staple-free stapler crimps the corners of paper to keep up to five sheets securely bound.



Manual Stapler

You can quickly staple documents at the MFP as needed without using a conventional stapler. A real time-saver if you want to, say, restaple documents that were unstapled for copying.



Office Direct Printing*

Print common Microsoft® Office files without using a PC. With a MX-M3550/M3050, you can print a Word, Excel®, or PowerPoint® file directly from a mobile device, cloud service, USB drive, or file server.

* Requires optional MX-PU10. The actual printout may look different from what is displayed on the computer screen. This function is enabled via DirectOffice™ technology.



High-Efficiency Scanning

The MX-M3550/M3050's standard-equipped 100-sheet RSPF (reversing single pass feeder) efficiently feeds in either one- or two-sided originals. With a scanning speed of up to 80 opm* (one-sided) for both colour and B/W documents, the MX-M3550/M3050 can complete large jobs with ease and efficiency.

* Originals per minute; when feeding A4 (8 1/2" x 11") sheets



Multiple Distribution of Scanned Files

Scanned documents can be distributed in a number of ways. For example, they can be sent as e-mail attachments or they can be scanned directly to an FTP server for storage. A compact PDF function*1 ensures that PDF files are sent and received smoothly. When you're scanning large-volume documents, the MFP saves the data on its hard disk and generates a URL for accessing that data*2. You can then e-mail recipients this URL rather than the full document, thereby reducing the load on the mail server.

*1: Requires optional MX-EB19. *2: Requires optional MX-HD16.

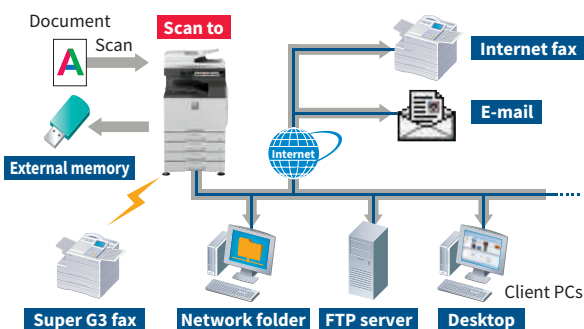

Automated Scanning*

Using advanced optical character recognition, these MFPs can correct the vertical orientation of pages mixed in upside down. This conveniently saves you the hassle of having to rescan those pages. The MFPs can also automatically determine scan resolution and skip blank pages in a multi-page document.

* Easy UI mode only. Requires optional MX-EB20.

Multicrop Function

The Multicrop function automatically creates separate files for multiple different-sized documents—such as receipts and bills—that are scanned simultaneously.

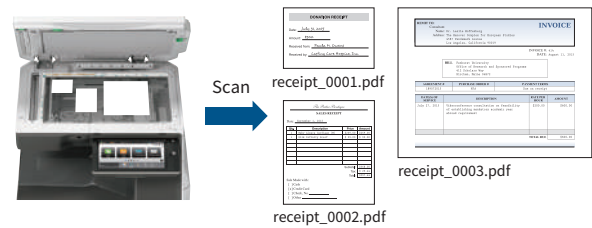

Image Crop Function

This function lets you scan multiple photos all at once and save each one as a separate file. It can also crop photos on documents such as magazine pages and save them as individual files.

Scan multiple photos



Crop photos from magazine page

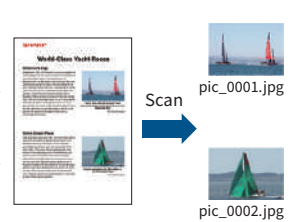

Business Card Management

It's easy to manage a database of business cards with the MX-M3550/M3050. The MFP reads contact details on each card via OCR* and then exports those details to a third-party contact management system of your choice.

* Requires optional MX-EB20.



Versatile Fax Functions (option)

- **Super G3 Fax** function
- **Internet Fax** lets you exchange faxes via e-mail
- **PC-Fax** sends PC documents directly to a fax machine via a phone line

SECURE INFORMATION SHARING

Link to Cloud Services*1

An MX-M3550/M3050 doesn't just connect to your local server. It also connects with cloud services directly from the MFP's control panel. You can upload scanned data to Google Drive, OneDrive for Business, SharePoint Online, or Box—or print directly from any of them*2. Using a cloud service like this can save you the time and cost of setting up and managing a server within your company. Once you log in to the MFP, its single sign-on feature allows you to quickly access multiple software services without having to sign in to each one separately. It's a true time-saver that gets your document jobs finished faster.

*1: Requires optional MX-AMX2. Contact a Sharp customer representative for details.

*2: Direct printing of PDF files requires optional MX-PK13; direct printing of Microsoft Office (pptx, xlsx, docx) files requires optional MX-PU10.

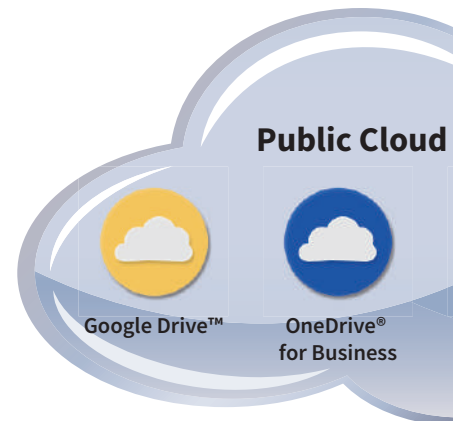

Link with Mail Servers

Scanned data can be conveniently sent via your regular Gmail™ or Microsoft Exchange/Online account. Sending e-mail is as easy as choosing a recipient from your address book on the mail server. Scanned data that you send can be stored on the mail server with other sent items.

Sharp OSA* (Open Systems Architecture)

Innovative Sharp OSA technology allows you to interact with critical business and network applications right from the LCD control panel, offering a new realm of control and convenience. And since Sharp OSA utilises industry-standard network protocols, the MX-M3550/M3050 can easily integrate with document management systems, enterprise resource planning software, workflow applications, and more. The latest version of Sharp OSA can reach beyond the firewall, enabling extensive system construction as well as services delivered over the Internet such as cloud services.

In this way, Sharp OSA provides a foundation for cost reductions and information sharing across the entire company organisation—effectively enhancing total business efficiency.

* Requires optional MX-AMX2 and/or MX-AMX3.

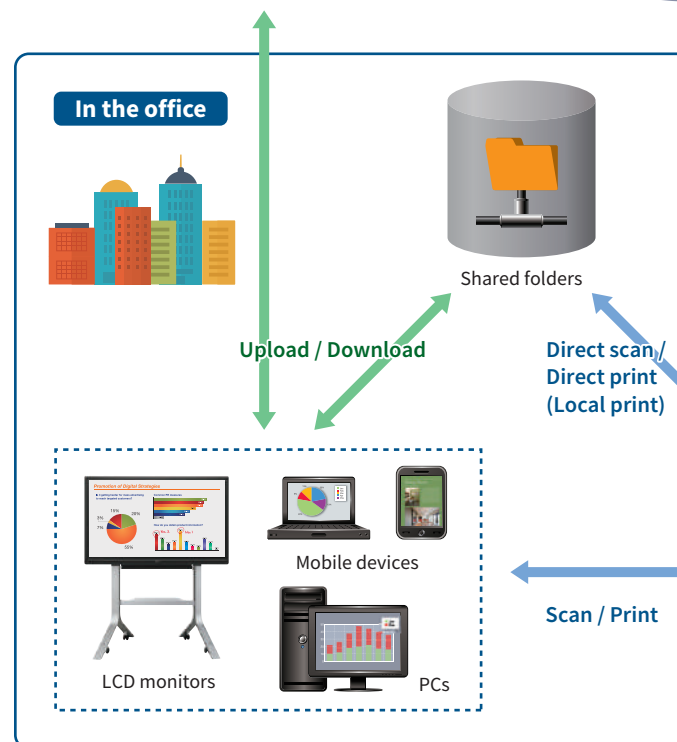

Seamless Document Management

Sharpdesk Document Management Software

Sharpdesk provides integrated desktop management of documents in over 200 file formats, including scanned paper-based documents and those created with popular applications such as Word. It allows you to organise, edit, search, and distribute your documents, all with simple drag-and-drop operation. Features include thumbnail viewing, annotation tools for paper-free proofreading, optical character recognition, full text search, and more.

Easy Sharing of Application Files

The MFP's hard disk* enables files created with applications such as Word and Excel to be saved in their original file format and shared across the office network.

* Requires optional MX-HD16. Sharp recommends backing up data saved to the MFP's hard disk.

Document Filing

Document Filing allows files that have been copied, printed, scanned, or faxed*1 to be stored by job in a Quick File folder, Main folder, or Custom folder on the MFP's hard disk*2. From there, they can be instantly recalled for printing and sending at a later time. The Main folder and Custom folder require users to enter a password for access, thereby protecting your sensitive data.

*1: For fax and Internet fax jobs, only transmitted data (not received faxes) can be saved via the Document Filing function.

*2: Requires optional MX-HD16.

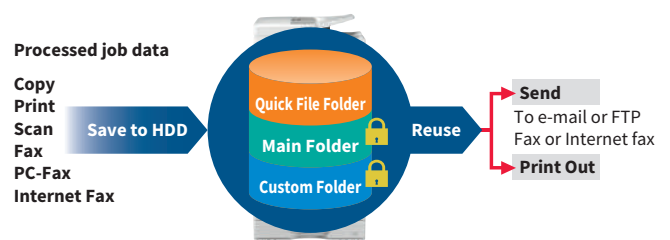

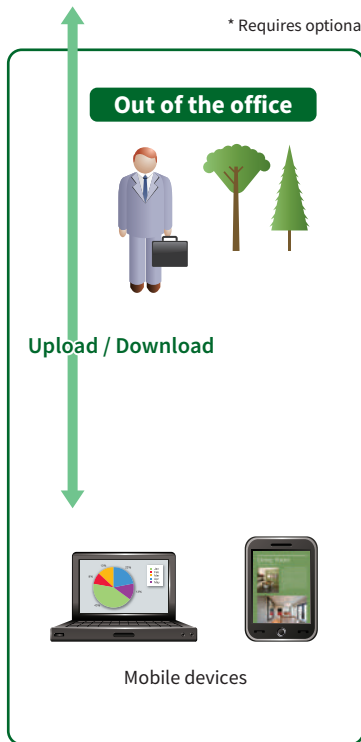
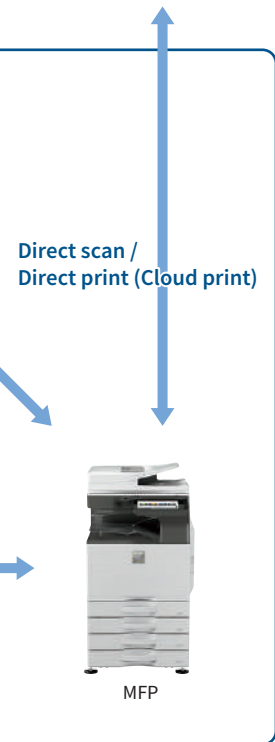
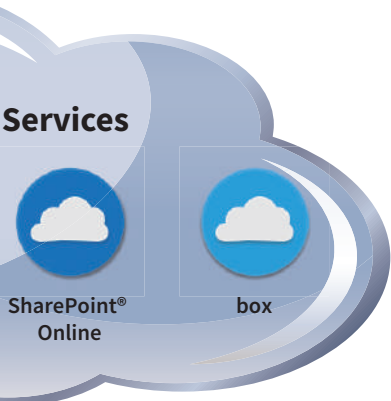

Two-Way Sharing with Mobile Devices

Connecting an MX-M3550/M3050 to one or more mobile devices is easy, and it expands your options for sharing data. Not only can you send scanned documents to mobile devices such as smartphones and tablets, you can also print documents or photos sent from those devices.

Sharpdesk Mobile*¹

Sharpdesk Mobile is a mobile print/scan app that connects the MFP to mobile devices. You can easily link your mobile device to the MFP by simply holding it over the MFP's NFC card reader*² or by scanning the MFP's QR Code®.

*1: Availability varies by country/region. For details, see the Sharpdesk Mobile support website: http://sharp-world.com/products/copier/docu_solutions/mobile/sharpdesk_mobile/

*2: The NFC interface is for Android™ devices. Requires commercially available NFC card reader. Contact a Sharp customer representative for details.

Mobile Printing Services*

These MFPs support Google Cloud Print, AirPrint, and Sharp Print Service Plugin.

* Requires optional MX-PK13.

Wireless Connections*

These MFPs offer ultra-handry wireless access via two easy modes, enabling convenient access to the MFP even from places where a wired LAN is not available.

* Requires optional MX-EB18. Availability of this option varies by country/region.

Infrastructure mode wirelessly connects the MFP to mobile PCs/devices via a commercially available wireless LAN router.

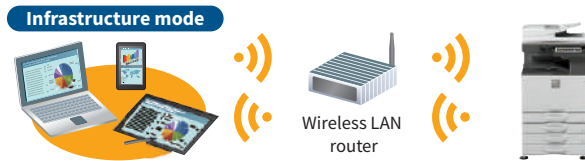

Access point mode wirelessly connects a LAN-wired MFP to mobile PCs/devices without going through a wireless LAN router.



Note: External networks cannot be accessed via the MFP. Up to five mobile devices can be wirelessly connected to the MFP at the same time.

Multi-Layered Security

Document Protection

- **Document Control** prevents unauthorised use of confidential documents by embedding copy prevention data in them

Note: Requires optional Data Security Kit and MX-HD16. May not work with certain types of paper, documents (such as those with a large volume of photos), or MFP settings.

- **Hidden Pattern Copy/Print** embeds a watermark, such as “Confidential” or “Not for Copy,” onto a document
- **Tracking Information Print** prints the MFP user’s name, the date, job ID, and other specifics on printouts



Data Protection

- Job data is automatically **encrypted** before being saved to the MFP’s internal storage. Once a job is finished, its encrypted data is **erased** by up to 10 automatic overwrites.

Note: Requires optional MX-HD16. Contact a Sharp customer representative for details on activating this function.

- Retained data can be **erased** when it’s time to replace the MFP, preventing the leakage of confidential information

Network Security and Access Control

- **S/MIME** provides secure e-mail communications*
* Only when e-mailing scanned data.
- **SSL** (secure sockets layer) and **IPsec** data encryption technologies ensure secure network communications
- **User Authentication** covering up to 1,000 users prevents unauthorised MFP use by requiring access passwords

10.1-Inch Colour LCD Touchscreen

A user-friendly touchscreen interface incorporating an Easy UI mode makes it easy and intuitive to operate the MFP. The Advanced Preview function, meanwhile, lets you check document finishes and page layout in advance, edit pages easily, and preview documents in various modes.



Preview mode (3D)



Edit mode (rotate)

Address Book

The address book has an easy-to-see layout that includes Frequent Use buttons, a separate Address list, and larger buttons, scroll bar, and text. This user-friendly design makes selecting the right scan/fax destinations more effortless than ever.

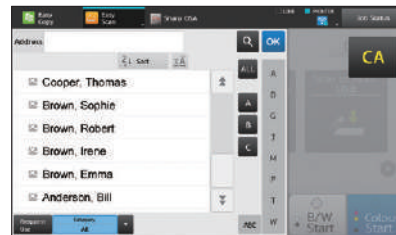

Accessibility

These MFPs comply with the accessibility guidelines outlined in US Section 508 and EU Mandate 376. This means that all user aspects—from the heights of the control panel and glass platen to the readability of the LCD—have been designed with consideration for usability by people with disabilities.

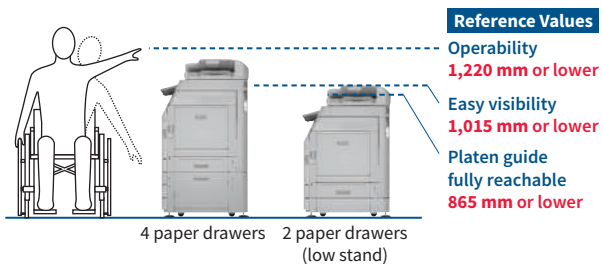

LED Status Lamps

Next to the control panel are two LED lamps: one red, one green. These light up to notify you—even from a distance—of the status of the machine.

3 LED lamp modes

Job status mode

Machine status mode

Accessibility mode*

* Indicates whether documents have been set in the document feeder



Utility Table

An optional Utility Table gives you a handy place to lay documents or a mobile device such as a tablet when you're working at the MFP. An IC card reader* can be built underneath the table.

* Commercially available



Free-Tilting Control Panel

The control panel can be tilted freely at various angles for easy viewing and easy operation, even from a wheelchair. Having the control panel at the perfect viewing angle means you can reduce eye strain and avoid making input errors.



Lock-on Handles

The paper drawers on these MFPs feature easy-grip, lock-on handles. As well as enabling easy opening and closing, they ensure that the paper drawers close properly, thereby enhancing safety in the event of a disaster such as an earthquake.



Remote Operation*

The Remote Operation function lets you display the MFP's main control panel on the screen of your PC or mobile device. From a remote location, you can then check MFP settings or reprint data stored on the MFP. This function also enables the administrator to guide an MFP user through necessary procedures and allows remote MFP operation from a wheelchair.

* Requires VNC application. Simultaneous remote operation from two or more PCs or mobile devices is not possible. Remote operation also depends on the network environment and applications being used. Contact a Sharp customer representative for details.

Direct Printing*/Scanning with USB Drives

Insert a USB drive into the MFP and a print/scan command screen will automatically pop up on the LCD. Right away you can print files from the USB drive—which are displayed as thumbnails—or you can scan documents directly to the USB drive.

* Direct printing of PDF files requires optional MX-PK13; direct printing of Microsoft Office (pptx, xlsx, docx) files requires optional MX-PU10.



Printer Driver with Easy Setup

The printer driver setup window features a simple design that includes larger buttons and drop-down menus, making it easier than ever to use printer functions.

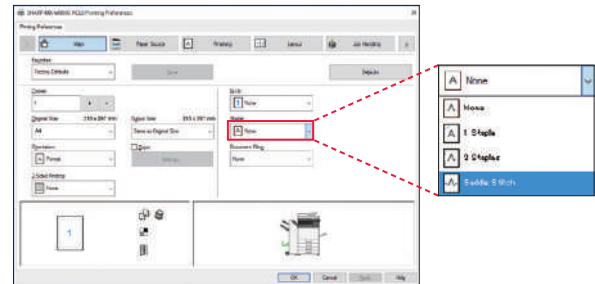

SUPERB IMAGE QUALITY

High-Resolution Output

Digital smoothing technology delivers print and copy resolution at the equivalent of 9,600 × 600 dpi, giving you ultra-clear image quality. Fine lines and small text come out looking crisper and easier to read.

Halftone Process Control

Halftone process control brings optimal monochrome gradation and outstanding image quality to high-volume copy/print jobs. Employing an image density sensor to enhance the stability and accuracy of each gradation, halftone process control ensures consistently high image quality from first page to last.

Line Width Adjustment

This function adjusts the width of lines. Fine lines, which are otherwise difficult to render properly, turn out sharp and crisp. Intricate line drawings, complex graphs and charts, and detailed spreadsheets are reproduced with exceptional quality and precision.

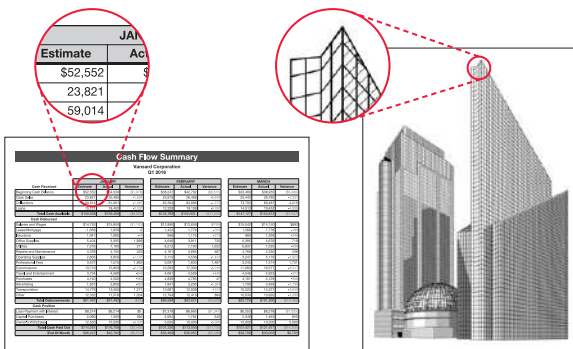

PCL 6 and True Adobe® PostScript® 3™

The MX-M3550/M3050 supports PCL 6 for enhanced font compatibility. And the optional MX-PK13 PS3 Expansion Kit brings compatibility with true Adobe PostScript 3 for improved graphics handling.

Easy, High-Quality Scanning

Through an advanced three-step process, **Auto Colour Mode** provides fully automated scanning in both colour and B/W—with a simple press of the Start button. Here's how it works: **Auto Colour Selection** automatically determines whether a page is colour or B/W. **Auto Original Type Selection** then analyses page contents to distinguish between different components (such as photos and text) and selects the appropriate mode. Finally, **Background Suppression** automatically removes unnecessary background colour.

Auto Colour Mode

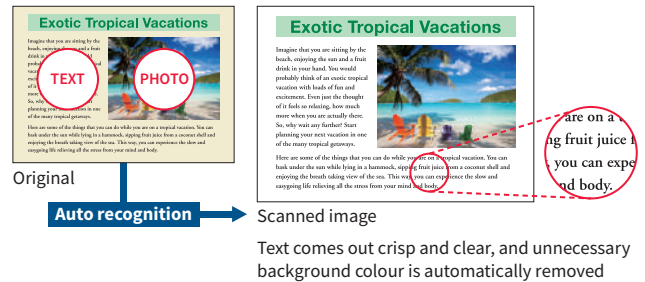

Clear, Easily Visible Copies

Auto Original Type Selection and **Background Suppression** are just as effective for copying as they are for scanning. Copies of documents that have a colour background—for example, newspaper articles, flyers, or invoices—come out superbly clear and legible.

Copying Originals with Highlighted Lines

Highlighter markings, such as lines, check marks, and circles on a document are usually hard to reproduce. But with these MFPs, they turn out clearly visible in copies.



ENVIRONMENT-FRIENDLY

Low Power Consumption

To reduce power consumption, Sharp has applied its advanced technologies across all areas of this MFP, including the hardware, software, electrical system, and supplies. As a result, the MX-M3550/M3050 delivers exceptional energy efficiency.

Eco-Friendly Toner

Mycrostoner-CAP is filled with low-melting-point material. This toner is able to fuse at low temperatures, resulting in reduced energy consumption.

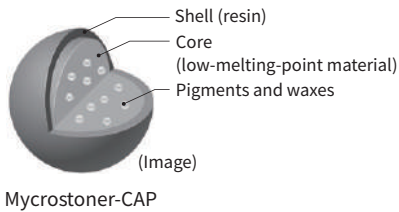

Eco Scan

The Eco Scan function saves energy by keeping the fusing system shut down during jobs that don't require its use—for example, during image sending and Document Filing.

Auto Power Shut-Off Mode

Based on prior usage patterns, the MFP automatically determines how long to wait before going into auto power shut-off mode. Shortly before this mode begins, a message appears on the LCD indicating that the MFP will soon shut down and giving you the option to continue operation.

Power ON/OFF Schedule

This function automatically turns the MFP on or off per administrator-set schedules.

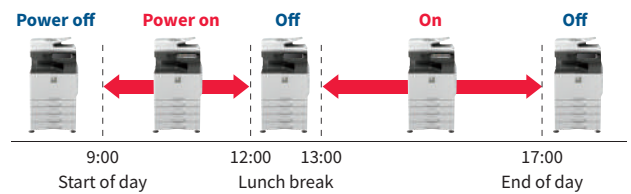

Eco Recommendation

This function suggests environmentally friendly settings before a print*/copy command is executed from the control panel.

* For printing Document Filing data and direct printing (FTP/SMB/USB)

SYSTEM CONFIGURATION

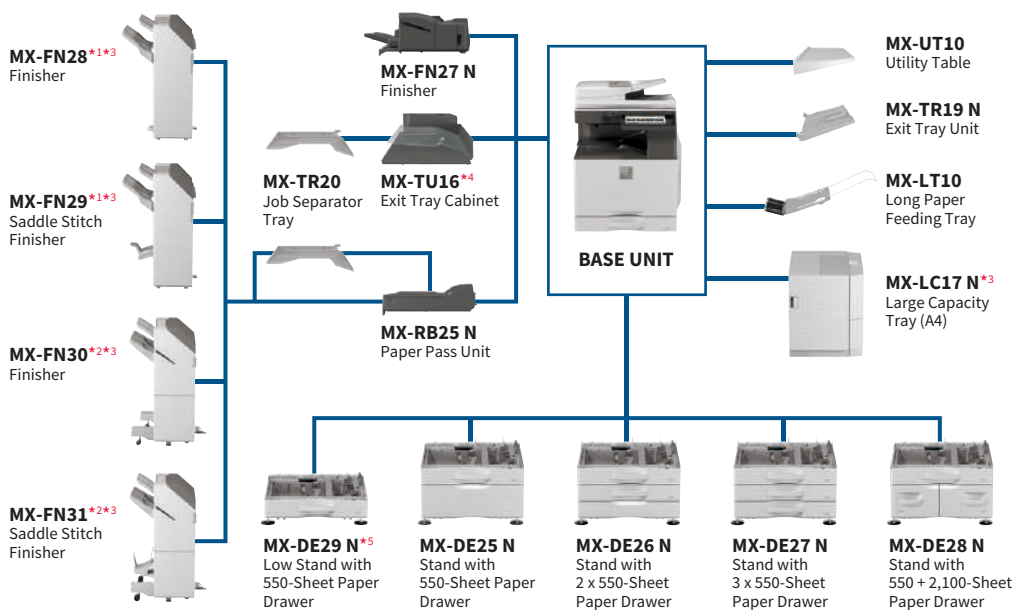

- MX-PN14B/C/D**
Punch Module (for MX-FN27 N)
- MX-PN15B/C/D**
Punch Module (for MX-FN28/FN29)
- MX-PN16B/C/D**
Punch Module (for MX-FN30/FN31)
- MX-PU10**
Direct Print Expansion Kit
- MX-PK13**
PS3 Expansion Kit
- MX-PF10**
Barcode Font Kit
- MX-FX15**
Fax Expansion Kit
- MX-FWX1**
Internet Fax Expansion Kit
- AR-SU1**
Stamp Unit
- MX-USX1/X5**
Sharpdesk 1/5-License Kit
- MX-US10/50/A0**
Sharpdesk 10/50/100-License Kit
- MX-AMX1**
Application Integration Module
- MX-AMX2**
Application Communication Module
- MX-AMX3**
External Account Module
- MX-EB18**
Wireless LAN Adaptor
- MX-EB19**
Enhanced Compression Kit
- MX-EB20**
OCR Expansion Kit
- MX-HD16**
Hard Disk Expansion Kit
- MX-FR56U***6
Data Security Kit

*1: Max. paper capacity: 1,000 sheets *2: Max. paper capacity: 3,000 sheets *3: Requires MX-DE25 N/DE26 N/DE27 N/DE28 N. Certain optional equipment may not be available in some areas.

*4: In some countries/regions, the MX-TU16 is standard-equipped (not optional) on the base unit. *5: Cannot be used with MX-FN28/FN29/FN30/FN31/LC17 N. *6: Requires optional MX-HD16.

SPECIFICATIONS FOR OPTIONAL EQUIPMENT

MX-TR20 Job Separator Tray

Paper size	A3W (12" x 18") to A5 (5 1/2" x 8 1/2"*)
Paper capacity	100 sheets (A4, 8 1/2" x 11")

MX-FN27 N Finisher

Paper size	Non offset	A3W (12" x 18") to A5 (5 1/2" x 8 1/2"*)
	Offset/staple	A3 (11" x 17") to B5*2 (8 1/2" x 11")
	Stapleless staple	A3 to B5*3 (11" x 17", 8 1/2" x 11"*)
Paper capacity	Non offset/offset	500 sheets (A4 or smaller), 250 sheets (B4 or larger)
	Staple	30 sets or 500 sheets (A4 or smaller), 30 sets or 250 sheets (B4 or larger)
	Stapleless staple	30 sets
Stapling capacity	Staple	50 sheets (A4, B5*), 30 sheets (A3, B4)
	Stapleless staple	5 sheets*5
	Manual staple	Total paper thickness 4 mm or less (40 sheets)
Staple position	Staple mode	3 locations (front, rear, or 2-point stapling)
	Stapleless staple mode	1 location (rear)
	Manual staple mode	1 location

MX-FN28 Finisher

Paper size	Non offset	A3W (12" x 18") to A5 (5 1/2" x 8 1/2"*)
	Offset	A3W (12" x 18") to A5 (5 1/2" x 8 1/2"*)
	Staple	A3W (12" x 18") to B5 (7 1/4" x 10 1/2"*)
Paper capacity	Finisher tray (non offset/offset)	1,000 sheets (A4), 500 sheets (other sizes)
	(staple)	100 sets or 1,000 sheets (A4), 50 sets or 500 sheets (other sizes)
	Top tray	250 sheets (A4 or smaller), 50 sheets (B4 or larger)
Stapling capacity		50 sheets (A4, B5), 30 sheets (A3W, A3, B4)
Staple position		3 locations (front, rear, or 2-point stapling)

MX-FN29 Saddle Stitch Finisher

Paper size	Non offset	A3W (12" x 18") to A5 (5 1/2" x 8 1/2"*)
	Offset	A3W (12" x 18") to A5 (5 1/2" x 8 1/2"*)
	Staple	A3W (12" x 18") to B5 (7 1/4" x 10 1/2"*)
Paper capacity	Finisher tray (non offset/offset)	1,000 sheets (A4), 500 sheets (other sizes)
	(staple)	100 sets or 1,000 sheets (A4), 50 sets or 500 sheets (other sizes)
	Top tray	250 sheets (A4 or smaller), 50 sheets (B4 or larger)
	Saddle stitch tray	7 sets of 11–15 sheets, 10 sets of 6–10 sheets, 20 sets of 1–5 sheets
Stapling capacity		50 sheets (A4, B5), 30 sheets (A3W, A3, B4)
Staple position		3 locations (front, rear, or 2-point stapling)

MX-FN30 Finisher

Paper size	Non offset	A3W (12" x 18") to A5 (5 1/2" x 8 1/2"*)
	Offset/staple	A3 (11" x 17") to B5*2 (8 1/2" x 11")
	Stapleless staple	A3, A4*4 (11" x 17", 8 1/2" x 11"*)
Paper capacity	Finisher tray (non offset/offset)	3,000 sheets (A4, B5), 1,500 sheets (other sizes)
	(staple)	200 sets or 3,000 sheets (A4, B5), 100 sets or 1,500 sheets (other sizes)
	(stapleless staple)	200 sets (A4), 100 sets (A3)
	Top tray	250 sheets (A4*4, B5*4, A5), 125 sheets (other sizes)
Stapling capacity	Staple	65 sheets (A4*4, B5*4), 30 sheets (other sizes)
	Stapleless staple	5 sheets*5
	Manual staple	Total paper thickness 9 mm or less (65 sheets)
Staple position	Staple mode	3 locations (front, rear, or 2-point stapling)
	Stapleless staple mode	1 location (rear)
	Manual staple mode	1 location

MX-FN31 Saddle Stitch Finisher

Paper size	Non offset	A3W (12" x 18") to A5 (5 1/2" x 8 1/2"*)
	Offset/staple	A3 (11" x 17") to B5*2 (8 1/2" x 11")
	Stapleless staple	A3, A4*4 (11" x 17", 8 1/2" x 11"*)
Paper capacity	Finisher tray (non offset/offset)	3,000 sheets (A4, B5), 1,500 sheets (other sizes)
	(staple)	200 sets or 3,000 sheets (A4, B5), 100 sets or 1,500 sheets (other sizes)
	(stapleless staple)	200 sets (A4), 100 sets (A3)
	Top tray	250 sheets (A4*4, B5*4, A5), 125 sheets (other sizes)
	Saddle stitch tray	10 sets of 11–20 sheets, 15 sets of 6–10 sheets, 25 sets of 1–5 sheets
Stapling capacity	Staple	65 sheets (A4*4, B5*4), 30 sheets (other sizes)
	Stapleless staple	5 sheets*5
	Manual staple	Total paper thickness 9 mm or less (65 sheets)
Staple position	Staple mode	3 locations (front, rear, or 2-point stapling)
	Stapleless staple mode	1 location (rear)
	Manual staple mode	1 location

Punch Modules

Model name	For MX-FN27 N	MX-PN14B *7	MX-PN14C *8	MX-PN14D
	For MX-FN28/FN29	MX-PN15B *7	MX-PN15C *8	MX-PN15D
	For MX-FN30/FN31	MX-PN16B *7	MX-PN16C *8	MX-PN16D
Number of holes		2 or 3	2 or 4	4 (wide)
Paper weight		55 to 300 g/m ² *9		

MX-TR19 N Exit Tray Unit

Paper size	A3W (12" x 18") to A5 (5 1/2" x 8 1/2"*)
Paper capacity	100 sheets (A4, 8 1/2" x 11")

MX-DE25 N Stand with 550-Sheet Paper Drawer

Paper size	A3W (12" x 18") to A5 (5 1/2" x 8 1/2"*)*10
Paper capacity	550 sheets

MX-DE26 N Stand with 2 x 550-Sheet Paper Drawer

Paper size	Upper and lower tray	A3W (12" x 18") to A5 (5 1/2" x 8 1/2"*)*10
Paper capacity	Upper and lower tray	550 sheets each

MX-DE27 N Stand with 3 x 550-Sheet Paper Drawer

Paper size	Upper/middle/lower tray	A3W (12" x 18") to A5 (5 1/2" x 8 1/2"*)*10
Paper capacity	Upper/middle/lower tray	550 sheets each

MX-DE28 N Stand with 550 + 2,100-Sheet Paper Drawer

Paper size	Upper tray	A3W (12" x 18") to A5 (5 1/2" x 8 1/2"*)*10
	Lower right tray	A4, B5, 8 1/2" x 11"
	Lower left tray	A4, 8 1/2" x 11"
Paper capacity	Upper tray	550 sheets
	Lower right tray	900 sheets
	Lower left tray	1,200 sheets

MX-DE29 N Low Stand with 550-Sheet Paper Drawer*11

Paper size	A3W (12" x 18") to A5 (5 1/2" x 8 1/2"*)*10
Paper capacity	550 sheets

MX-LC17 N Large Capacity Tray

Paper size	A4, B5, 8 1/2" x 11"
Paper capacity	3,000 sheets

MX-LT10 Long Paper Feeding Tray

Paper size	Max. 1,300 mm long
Paper capacity	1 sheet

Note: All specifications relating to paper capacity refer to 80 g/m² paper.

*1: Only short-edge feeding can be used with 5 1/2" x 8 1/2" paper. *2: Only long-edge feeding can be used with B5 paper. *3: Only long-edge feeding can be used with A4 and B5 paper. *4: Long-edge feeding. *5: Guaranteed stapleable weight is up to 64 g/m² (4 sheets up to 81.4 g/m² and 3 sheets up to 105 g/m²). *6: Only short-edge feeding can be used with 7 1/4" x 10 1/2" paper. *7: Accepts North American paper sizes. *8: Accepts ISO-standard paper sizes. *9: Guaranteed punchable weight is 60 to 128 g/m². *10: Only short-edge feeding can be used with A5 (5 1/2" x 8 1/2") paper. *11: Desktop use is also possible. Contact a Sharp customer representative for details.

SPECIFICATIONS (tentative)

General

Type	Desktop
Engine speed	A4 (8 1/2" x 11") ^{*1} : Max. 35/30 ppm A3 (11" x 17") ^{*2} : Max. 17/15 ppm A3W (12" x 18") ^{*3} : Max. 16/14 ppm
Control panel display	10.1-inch colour LCD touchscreen
Paper size	Max. A3W (12" x 18"), min. A5 (5 1/2" x 8 1/2") ^{*2}
Paper capacity (80 g/m ²)	Standard: 650 sheets (550-sheet tray and 100-sheet multi-bypass tray) Maximum: 6,300 sheets (650 sheets & optional 550 + 2,100-sheet tray and 3,000-sheet tray)
Paper weight	Tray: 60 g/m ² to 300 g/m ² (16 lbs bond to 110 lbs cover) Multi-bypass tray: 55 g/m ² to 300 g/m ² (13 lbs bond to 110 lbs cover)
Warm-up time ^{*3}	14 sec. ^{*4}
Memory	Standard: 5 GB (copy/print shared) Option: 500 GB HDD ^{*5}
Power requirements	Rated local AC voltage ±10%, 50/60 Hz
Power consumption	Max. 1.84 kW (220 V to 240 V), max. 1.65 kW (110 V)
Dimensions (W x D x H) ^{*6}	608 x 650 x 834 mm (23 15/16" x 25 19/32" x 32 27/32")
Weight (approx.)	64 kg (141.1 lbs)

Copier

Original paper size	Max. A3 (11" x 17")
First copy time ^{*7}	4.5 sec.
Continuous copy	Max. 9,999 copies
Resolution	Scan: 600 x 600 dpi, 600 x 400 dpi Print: 600 x 600 dpi, 9,600 (equivalent) x 600 dpi (depending on copy mode)
Gradation	Equivalent to 256 levels
Zoom range	25% to 400% (25% to 200% using RSPF) in 1% increments
Preset copy ratios	Metric: 10 ratios (5R/5E), inch: 8 ratios (4R/4E)

Network Colour Scanner

Scan method	Push scan (via control panel) Pull scan (TWAIN-compliant application)
Scan speed ^{*8}	[Colour & B/W] Max. 80 originals/min.
Resolution	Push scan: 100, 150, 200, 300, 400, 600 dpi Pull scan: 75, 100, 150, 200, 300, 400, 600 dpi 50 dpi to 9,600 dpi via user setting ^{*9}
File formats	TIFF, PDF, PDF/A-1a ^{*10} , PDF/A-1b, encrypted PDF, compact PDF ^{*11,12} , JPEG ^{*12} , XPS, searchable PDF ^{*13} , OOXML (docx, xlsx, pptx) ^{*13} , text (TXT [UTF-8]) ^{*13} , rich text (RTF) ^{*13}
Scanner utility	Sharpdesk
Scan destinations	Scan to e-mail/desktop/FTP server/network folder (SMB)/USB drive/HDD ^{*14}

- *1: Long-edge feeding.
- *2: Only short-edge feeding can be used with 5 1/2" x 8 1/2" paper.
- *3: In a standard measurement environment. May vary depending on operating conditions and environment.
- *4: When starting the MFP via the power button. 27 sec. when starting via the main power switch.
- *5: HDD capacity depends on procurement and sourcing status.
- *6: Including adjusters and protrusions.
- *7: Long-edge feeding of A4 (8 1/2" x 11") sheets from 1st paper tray, using document glass, MFP in fully ready condition. May vary depending on operating conditions and environment.
- *8: Based on Sharp's A4 standard chart, using document feeder, long-edge feeding, one-sided scanning, and factory default settings. Scan speed will vary depending on the type of document and the scan settings.
- *9: Resolution will vary depending on the size of the scanned area.
- *10: Requires optional MX-EB20.
- *11: Requires optional MX-EB19.
- *12: Colour/greyscale only.
- *13: Requires optional MX-EB20.
- *14: Requires optional MX-HD16.
- *15: Storage capacity will vary depending on the type of document and the scan settings.
- *16: Some features require option(s).
- *17: Mac OS requires optional MX-PK13.
- *18: Based on Sharp's standard chart with approx. 700 characters (A4 or 8 1/2" x 11" long-edge feeding) at standard resolution in Super G3 mode, 33,600 bps, JBIG compression.

Document Filing (requires optional MX-HD16)

Document filing capacity ^{*15}	Main and custom folders: 20,000 pages or 3,000 files Quick file folder: 10,000 pages or 1,000 files
Stored jobs ^{*16}	Copy, print, scan, fax
Storage folders	Quick file folder, main folder, custom folder (max. 1,000 folders)

Network Printer

Resolution	600 x 600 dpi, 9,600 (equivalent) x 600 dpi
Interface	USB 2.0 (host, high-speed), 10Base-T/100Base-TX/1000Base-T
Supported OS ^{*17}	Windows Server [®] 2008, Windows Server [®] 2008 R2, Windows Server [®] 2012, Windows Server [®] 2012 R2, Windows Server [®] 2016, Windows [®] 7, Windows [®] 8.1, Windows [®] 10, Mac OS 10.6, 10.7, 10.8, 10.9, 10.10, 10.11, 10.12, 10.13
Network protocols	TCP/IP
Printing protocols	LPR, Raw TCP (port 9100), POP3 (e-mail printing), HTTP, FTP for downloading print files, IPP, SMB, WSD
PDL	Standard: PCL 6 emulation Option: Adobe [®] PostScript [®] 3 [™]
Available fonts	80 fonts for PCL, 139 fonts for Adobe PostScript 3

Facsimile (requires optional MX-FX15)

Compression method	MH/MR/MMR/JBIG
Communication protocol	Super G3/G3
Transmission time	Less than 3 seconds ^{*18}
Modem speed	33,600 bps to 2,400 bps with automatic fallback
Transmission resolution	From Standard (203.2 x 97.8 dpi) to Ultra Fine (406.4 x 391 dpi)
Recording size	A3 to A5 (11" x 17" to 5 1/2" x 8 1/2")
Memory	1 GB (built-in)
Greyscale levels	Equivalent to 256 levels

- Design and specifications are subject to change without prior notice.
- Google Drive, Google Cloud Print, Gmail, and Android are trademarks of Google LLC. The Google Drive trademark is used with permission from Google LLC. OneDrive, SharePoint, Active Directory, Microsoft, Excel, PowerPoint, Windows Server, and Windows are either registered trademarks or trademarks of Microsoft Corporation in the US and/or other countries. Box is a trademark, service mark, or registered trademark of Box, Inc. AirPrint and Mac are trademarks of Apple Inc., registered in the US and other countries. QR Code is a registered trademark of DENSO WAVE INCORPORATED in Japan and other countries. PCL is a registered trademark of Hewlett-Packard Company. Adobe and PostScript 3 are either registered trademarks or trademarks of Adobe Systems Incorporated in the US and/or other countries. Mycrostoner-CAP is a trademark of Sharp Corporation. DirectOffice is a product of CSR Imaging US, LP. DirectOffice is a trademark of CSR Imaging US, LP, registered in the US and other countries, used with permission. All other brand names and product names may be trademarks or registered trademarks of their respective owners.

DIRECTOffice

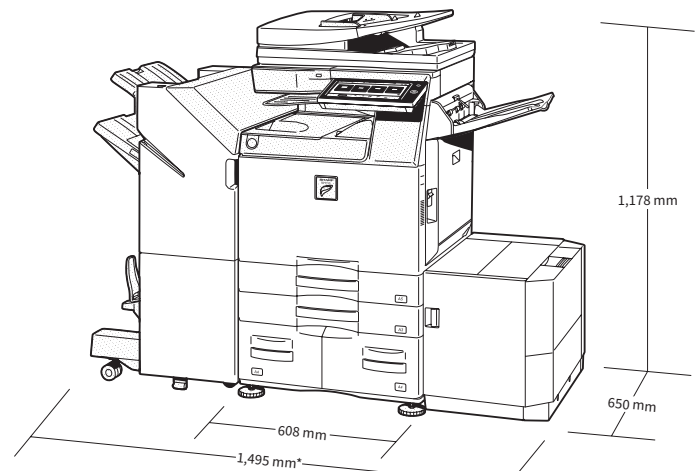

* 1,649 mm when finisher tray and exit tray are extended.

Shown with optional equipment.

Distributed by:

SHARP